

ICaXTM ltd

Integration of Renewable Technologies

Where are the synergies?

Edward Thompson





Half the energy used in the UK is used within buildings
- for heating, cooling and power.

Over 90% currently comes from fossil fuels.

What renewable technologies are available?

Why integrate?

Do the available pieces of this jigsaw puzzle fit together?



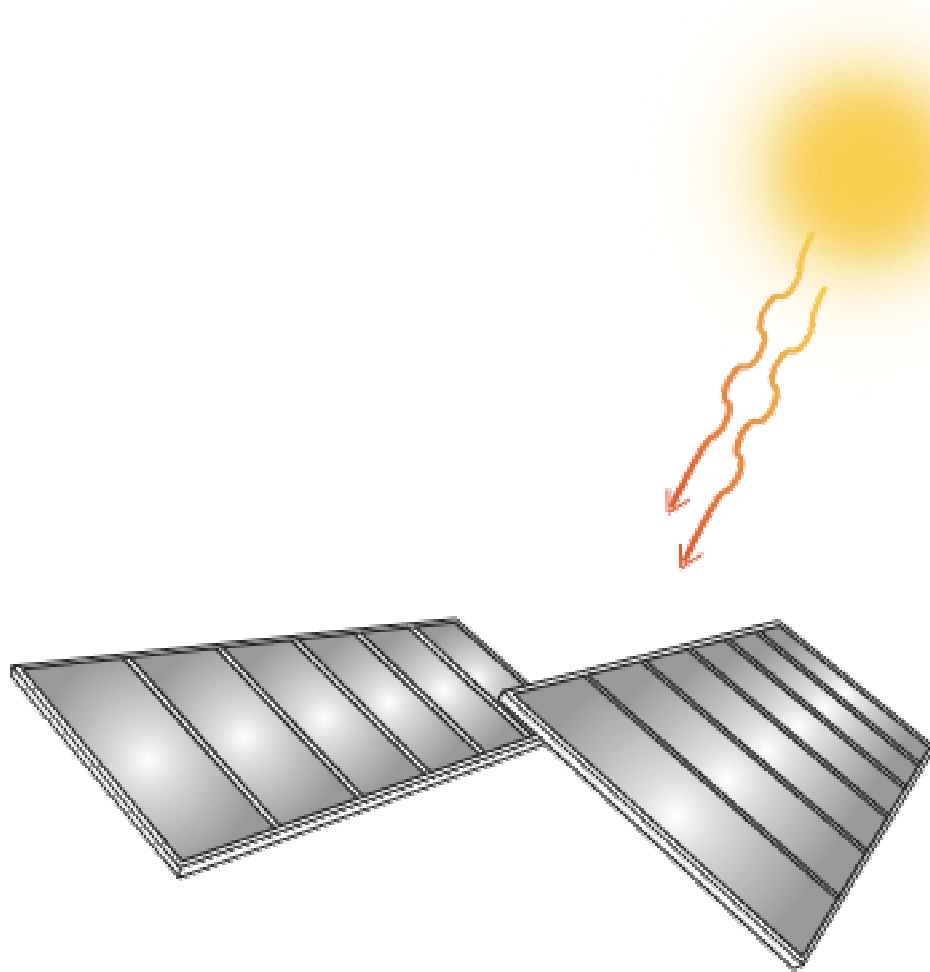

Photovoltaic

- Generates electricity
- When the sun shines
- Efficiency of only 12%
- Difficult to store surplus electricity
- High capital cost



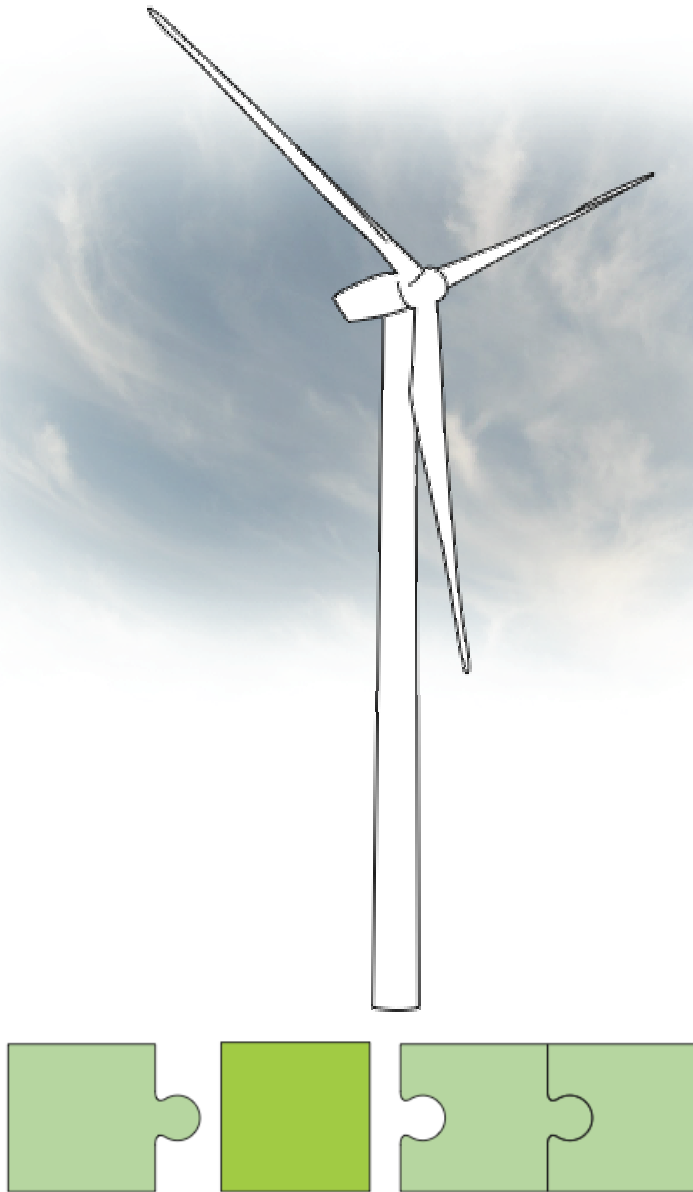

Wind turbine

- Generates electricity
- $\text{Radius}^2 \text{ Wind speed}^3$
- When the wind blows
- If used on a large scale
- Difficult to store surplus electricity
- High capital cost
- Reliability and maintenance?
- Planning permission?

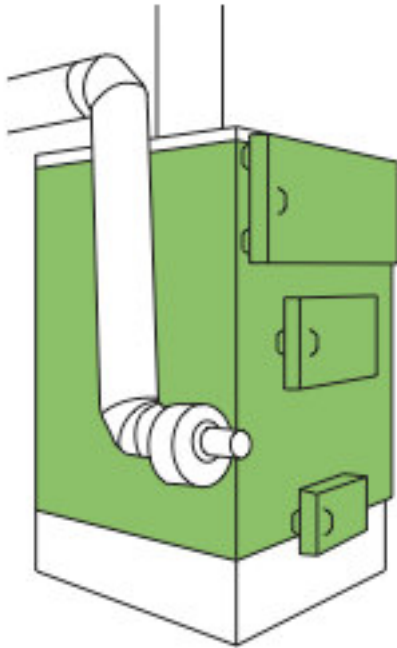

Biomass Boiler

- + Generates heat
- + Cheap to buy
- Expensive to install
- On-going management costs
- Not good for hot water in summer
- No good for cooling
- Continuity of supply?
- Generates CO₂
- long route from the sun (many years)



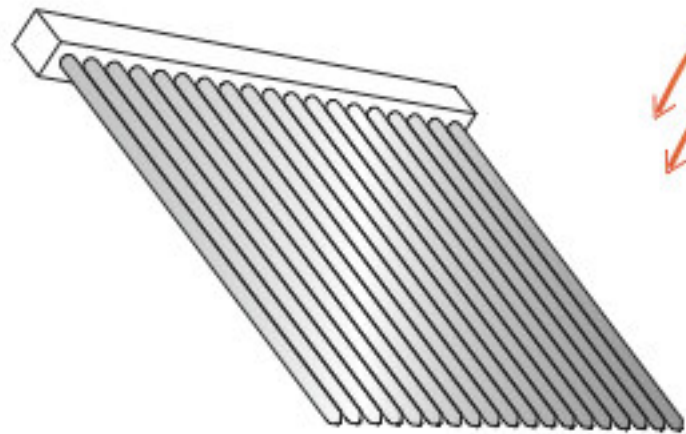

Solar Thermal

- Short route from the sun (six minutes)
- Generates hot water
- Efficient technology and affordable
- Some heat in winter
- Lots of heat in summer
- Overheating in summer?
- Where to store all the heat?
- The real need is space heating in winter
- A valuable piece in the jigsaw

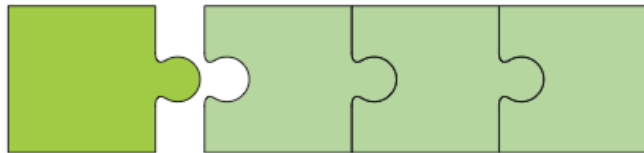

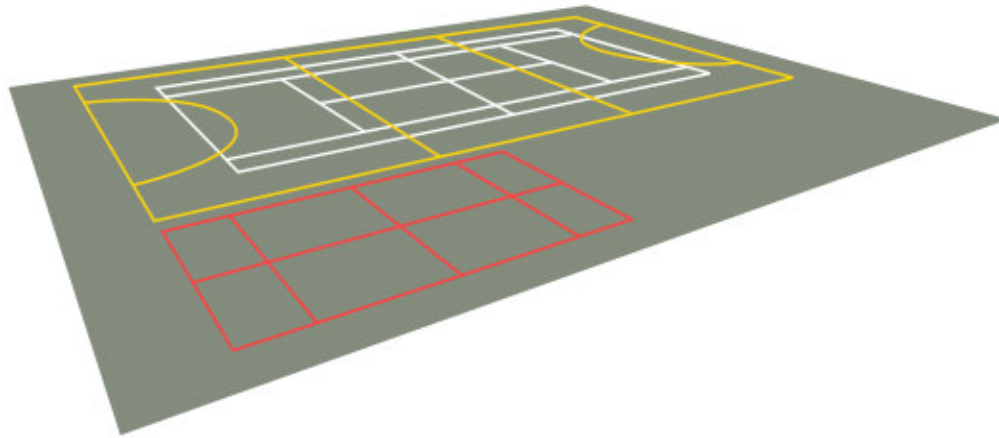

ICAX Asphalt Solar Collector

- Black surfaces absorb heat
- Lots of heat in summer
- Cheaper than solar panels
- Gives second function to tarmac
 - car parks
 - playgrounds
 - access roads
- Invisible – no planning issues
- Where to store surplus heat?

“Seasonal Thermal Storage is the Holy Grail of the renewables industry”.



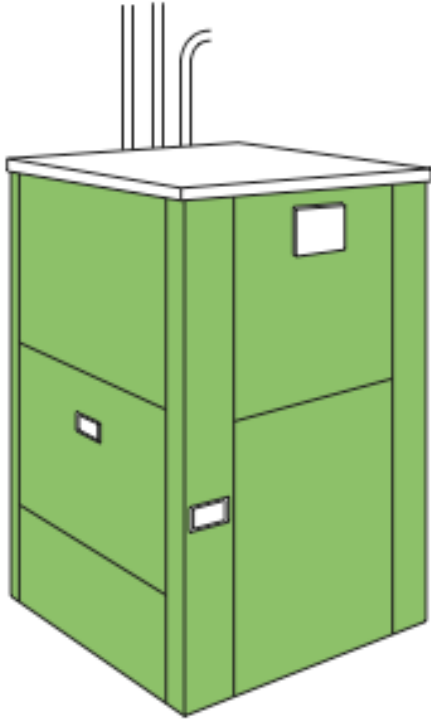

Heat Pump

- Transfers heat from ground
- Coefficient of Performance of 4 in autumn
- In standard conditions
- But CoP falls as heat is extracted from ground

“Temp is a constant 10°C at 7m depth – across the country – from summer to winter”.

But, this is only true if you don't extract the heat.

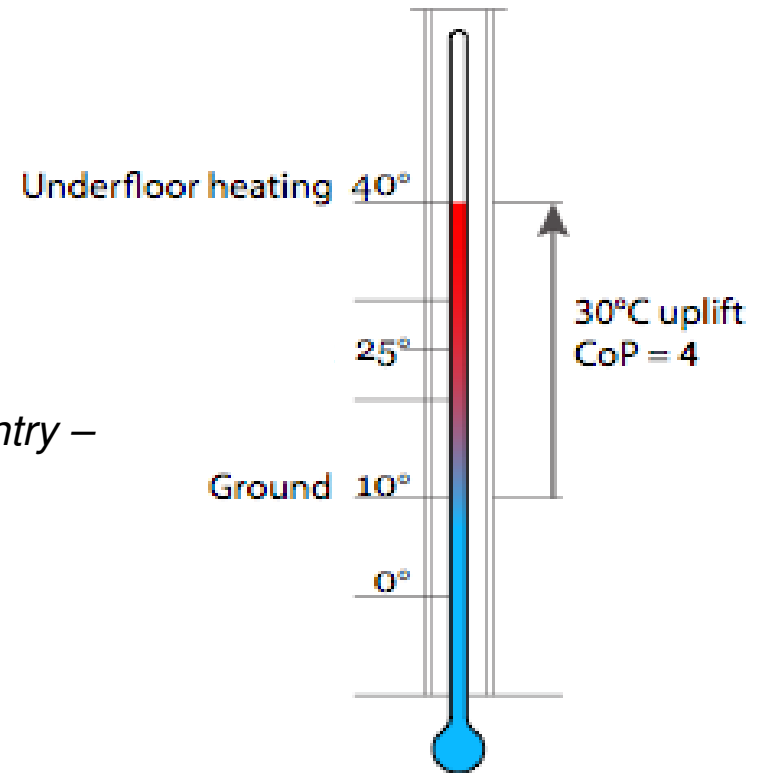
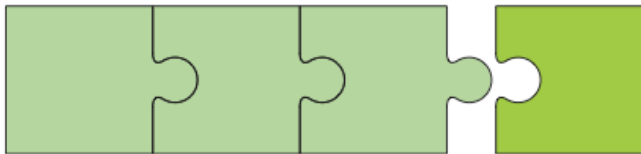

ICaXTM ltd

ICAX has been studying
Seasonal Thermal Storage
for many years, and especially the
movement of heat in the ground.

ICAX has invented, developed and
patented the critical link needed to
complete the jigsaw puzzle.



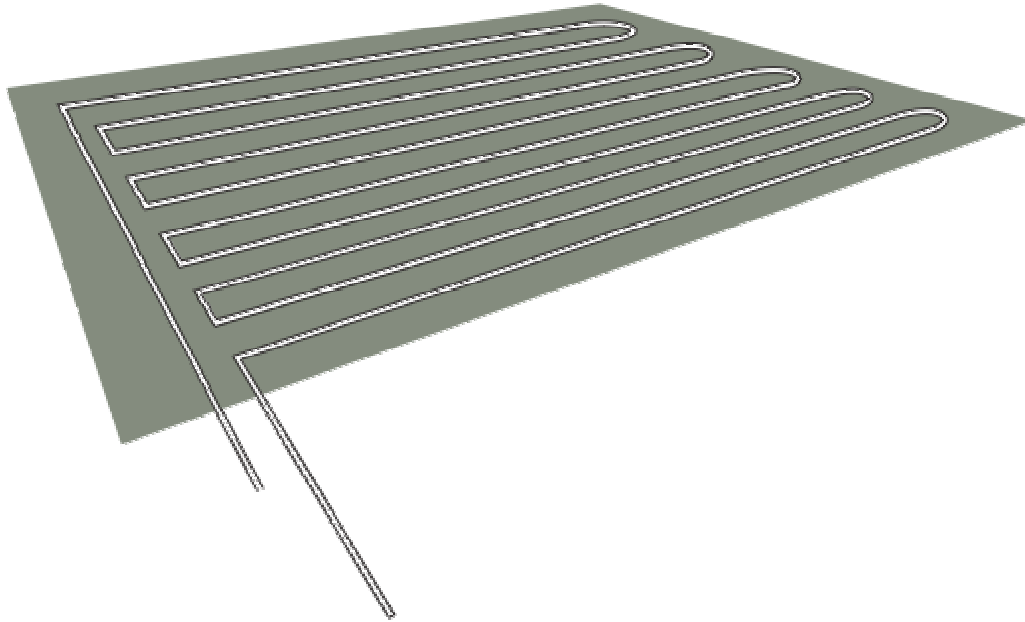

ICAX ThermalBank™

- Stores heat in the ground
- Between seasons
- Until needed in winter
- For space heating
- A critical piece of the jigsaw



ICaXTM ltd

So, we have examined the pieces of
the jigsaw.

Which pieces can we use to achieve a
complementary integration?



Interseasonal Heat Transfer™

Collects heat in summer
Stores heat in ThermalBanks
Releases heat in winter
To heat building
Without burning fossil fuels

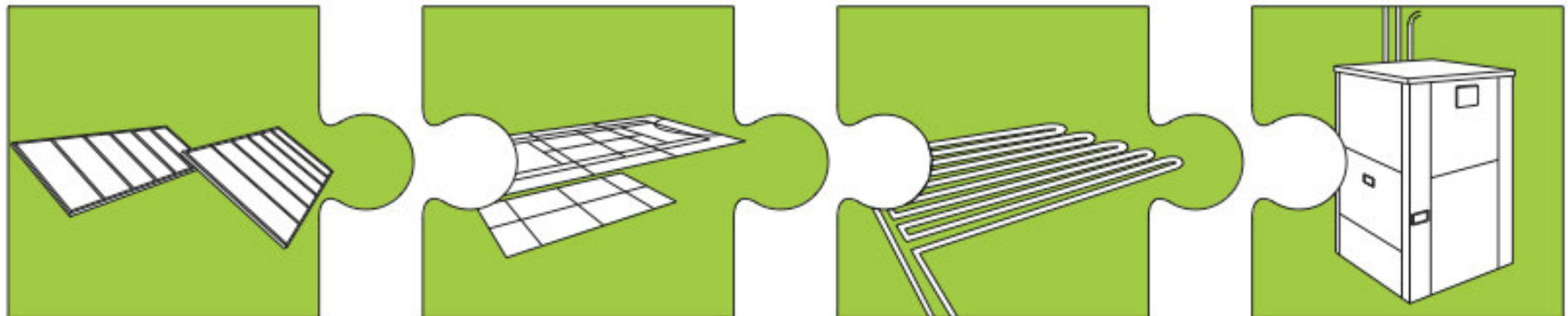

Solar Thermal + Asphalt Solar + ThermalBank + Heat Pump

= Successful Integration

Interseasonal Heat Transfer

Collects solar heat in summer

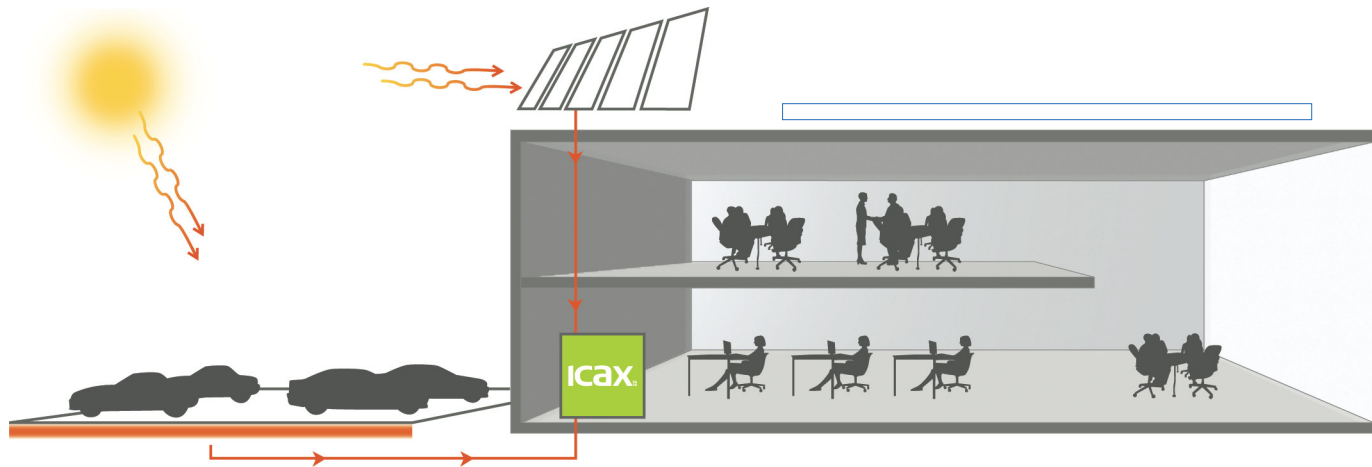

Interseasonal Heat Transfer

Stores heat in a ThermalBank
raising ground from 10°C to 25°C

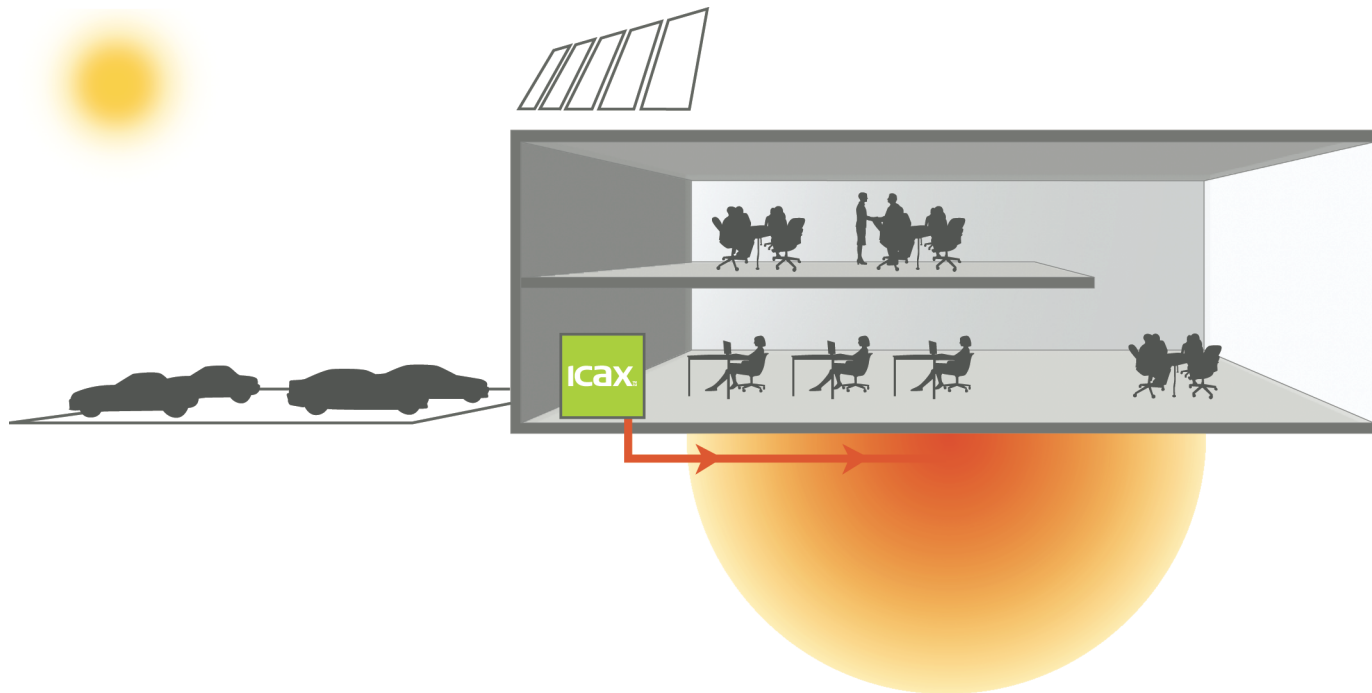

Interseasonal Heat Transfer

Doubles the performance of heat pumps
By starting with warmth
from Thermal Banks

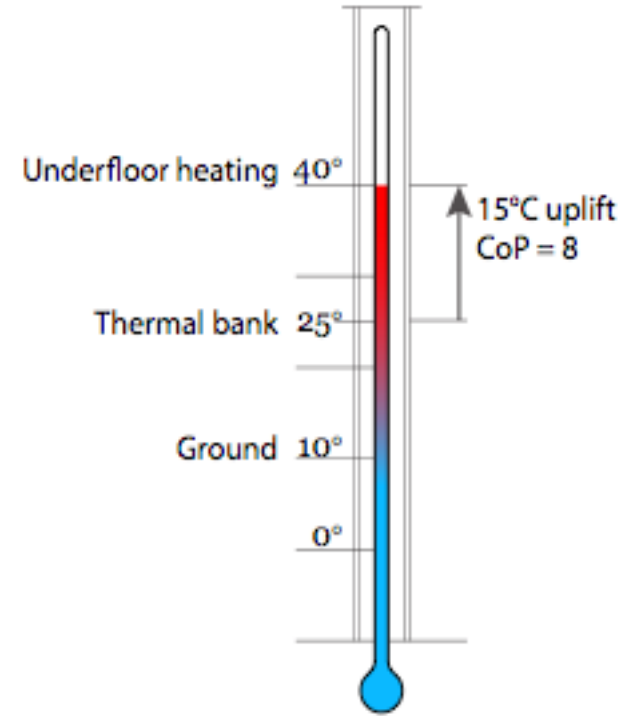
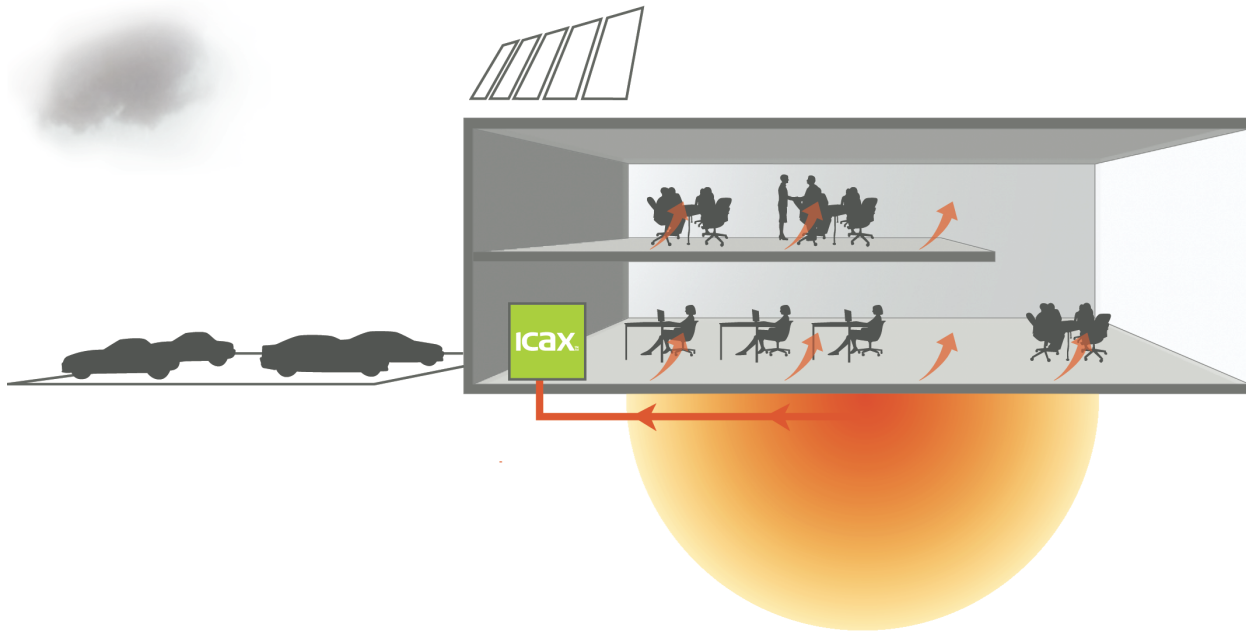

ICaXTM ltd

ICAX has demonstrated successful
integration for heating.

ICAX is able to take integration further
than this.

Cooling has become a key issue in
well-insulated, well-designed buildings.



Interseasonal Heat Transfer

Collects cold temp in winter

Stores it in a ThermalBank

Reducing ground temp to 3°C

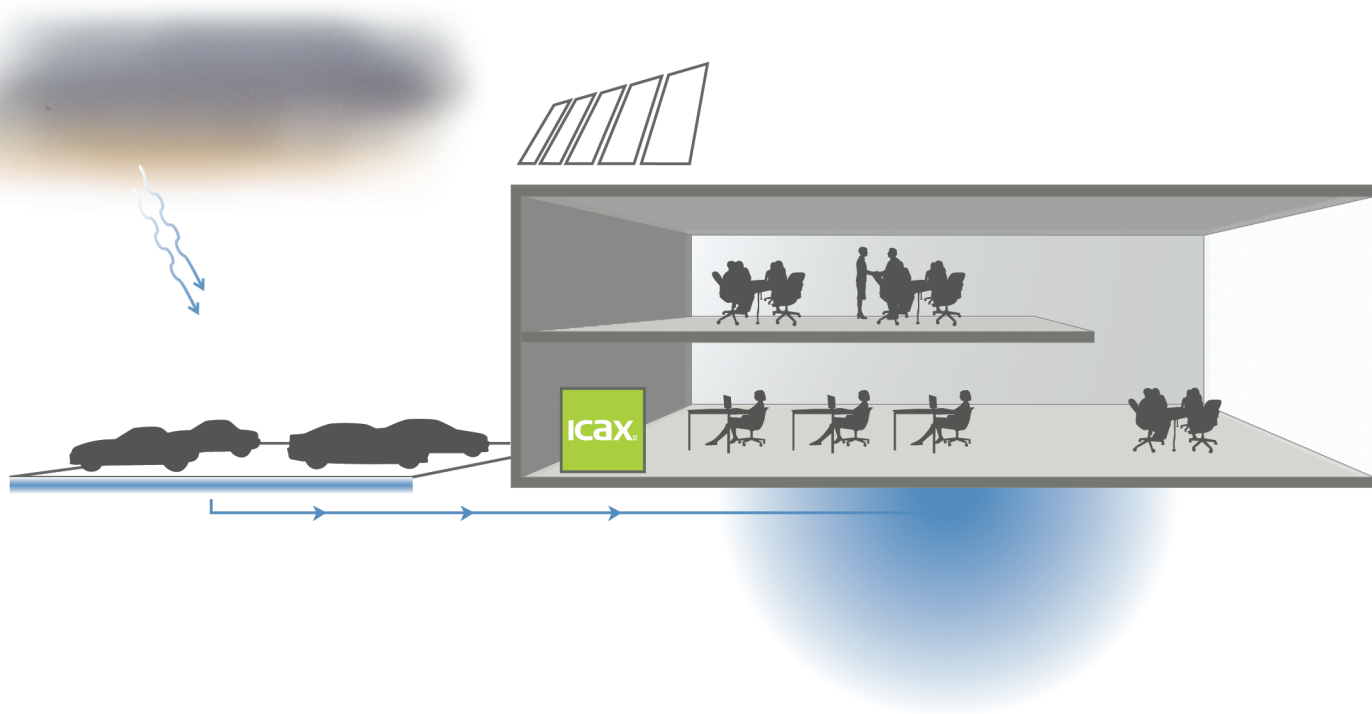

And releases coolth in summer to cool buildings,
at a fraction of the cost of air conditioning.

A CoP of 20 can be achieved by use of just a circulation
pump to allow heat to escape to a cold ThermalBank.

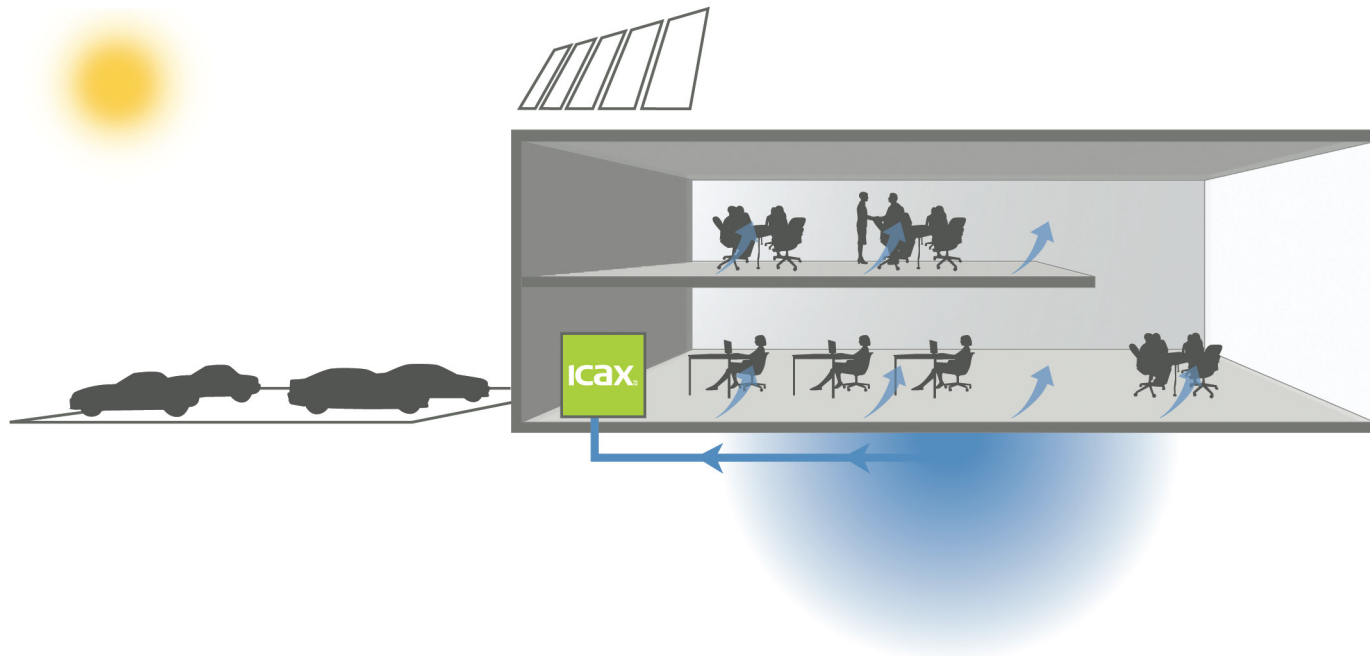

ICaXTM ltd

INTERSEASONAL HEAT TRANSFER

Gives you the carbon offset you need
to comply with The Merton Rule.

Edward Thompson



Interseasonal Heat Transfer

Case studies:

- Toddington – Under Road Heating
- Howe Dell School
- Garth Prison
- Hiroshima
- Merton Intergenerational Centre
- Suffolk One
- Tesco Greenfield Supermarket
- Wellington Civic Centre



Case Studies – Toddington Demonstration

Highways Agency
Under Road Heating



Case Studies – Toddington Demonstration

Highways Agency
Under Road Heating



Howe Dell School

Increases the performance of heat pumps by starting with warmth from Thermal Banks



Garth Prison

Exercise yard doubles as solar collector



Hiroshima

Misawa tests IHT in Japan under licence from ICAX



Merton Intergenerational Centre

Over 44% on site renewable energy



Merton Intergenerational Centre

Merton Rule

Modular building

Low thermal mass

Heating load

Cooling load

Budget blown

Interseasonal Heat Transfer

Intrabuilding Heat Transfer

Over 44% on-site renewable energy



Merton Intergenerational Centre

ICAX Skid, controls system energy flows

Interseasonal Heat Transfer

Intrabuilding Heat Transfer



Suffolk One - £65m Sixth Form College

Doubles the performance of heat pumps
by starting with warmth from Thermal Banks



Suffolk One

Solar Collector Array in construction – bus turning area



Tesco Greenfield Supermarket

Renewable Cooling – heat transfer to ThermalBank in summer
Renewable Heat – heat transfer from ThermalBank in winter



Interseasonal Heat Transfer

Integrates renewable technologies:

Solar Thermal Collection
Seasonal Heat Storage in Thermalbanks
Heat pump delivery

Economic Renewable Energy



ICaXTM Ltd



INTERSEASONAL HEAT TRANSFER

ThermalBanks

Renewable Heat

Renewable Cooling

www.icax.co.uk

